

ANGIE

Silla ANGIE
Chair ANGIE
Chaise ANGIE

Instrucciones de Montaje
Assembly Instructions
Notice de Montage
Istruzioni di Montaggio
Instruções de Montagem
Montageanleitung

Version 19/12/2025

19594 EAN Code: 8435178346568

19596 EAN Code: 8435178346575

19597 EAN Code: 8435178346582

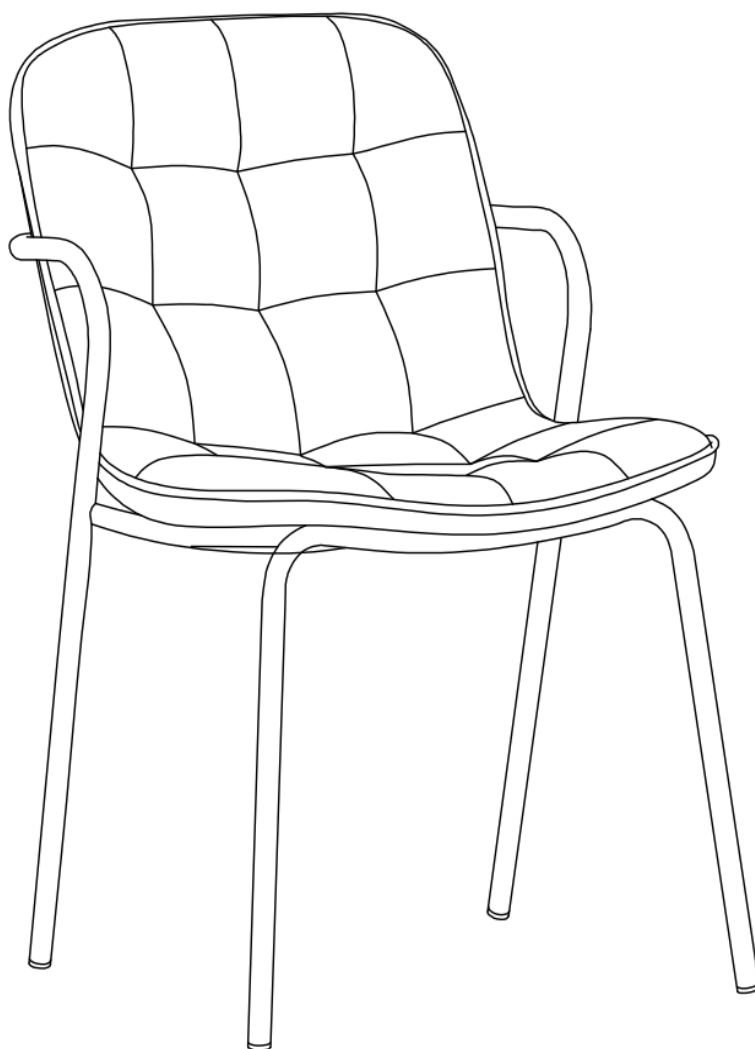

MARCKERIC S.L.

c/ Enlace Verola S/N
46430 Sollana - Valencia (SPAIN)
ventas@marckeric.com

MARCKERIC



- ES:** → **IMPORTANTE:** Antes de empezar, este mueble requiere montaje. Lea atentamente las instrucciones de montaje y consérvelas para futuras consultas.
- Este mueble es para uso doméstico
 - Compruebe que tiene toda la tornillería y todas las piezas antes de empezar el montaje.
 - No monte ni utilice el mueble si hubiera piezas rotas o dañadas o si faltaran piezas, y emplee únicamente piezas aprobadas por el fabricante.
 - Apriete firmemente las fijaciones y emplee únicamente las herramientas suministradas o recomendadas.
 - El montaje, el apuntalamiento o la manipulación incorrectos podrían debilitar el ensamblado de las piezas.
 - Mantenga a los niños alejados durante el montaje. El producto contiene piezas pequeñas que podrían ingerirse.
 - Todas las uniones deberán apretarse adecuadamente y verificarse periódicamente, volviéndolas a apretar si fuera necesario.
 - No desplace un mueble que esté cargado.
 - El mueble no está diseñado para volverse a montar.
 - Si hubiera piezas de la silla dañadas o gastadas, deje de usar la silla y sustitúyala.
 - ¡ADVERTENCIA! No utilice este asiento para personas con discapacidad física y que necesiten una posición sentada continuada y frecuente. Este producto deberá utilizarse en un entorno de ocio o relajación. Este producto no cumple con las normas en vigor para material médico.
 - En las sillas con elevación por gas, el cambio o la reparación de la elevación por gas deberán ser efectuados por una persona cualificada.
 - En las sillas con sistema de inclinación, la inclinación por encima de 120° no es considerada un uso normal del producto. Tenga en cuenta el riesgo de vuelco hacia atrás.
 - En las sillas, sillones y sofás con brazos, el brazo no es ni una mesa ni un asiento: por tanto, no se sienta sobre el mismo.

- EN:** → **IMPORTANT:** Before starting, this furniture self-assembly required. Please read the assembly instructions carefully and keep them for future reference.
- This furniture is for domestic use.
 - Check that all of the hardware and parts are present and in good condition before starting assembly.
 - Do not assemble or use the furniture if any of the parts are broken, damaged or missing, and only use parts approved by the manufacturer.
 - Firmly tighten the fasteners and use only the tools supplied or recommended.
 - Improper assembly, cribbing or handling can lead to assemblies and/or parts becoming weakened.
 - Keep young children away during assembly. The product contains small parts that could be ingested.
 - All joints should always be properly tightened and regularly checked, and retightened, if necessary.
 - Do not move furniture that is loaded.
 - Furniture is not intended to be reassembled.
 - If parts of the chair are damaged or worn, discontinue use and replace it.
 - **WARNING!** Do not use this seat for people suffering of a physical handicap, and needing a seated continue and frequent position. This product shall be used in a frame of leisure or relaxation. This product does not comply with the norms in force for medical material.
 - In chairs with gas lift, the replacement or repair of the gas lift must be carried out by a qualified person.
 - In chairs with a tilting system, reclining beyond 120° is not considered normal use of the product. Please be aware of the risk of tipping backwards.
 - In chairs, armchairs, and sofas with armrests, the armrest is neither a table nor a seat: therefore, do not sit on it.

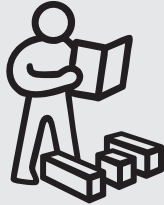

- FR:** → **IMPORTANT:** Avant de commencer, ce meuble a monter soi-même. Lisez attentivement les notices de montage et conservez-les pour référence ultérieure.
- Ce meuble est à usage domestique.
 - Vérifier la présence et l'état de la quincaillerie et des pièces avant de débiter le montage.
 - Ne pas monter ou utiliser le mobilier si certains éléments sont cassés, endommagés ou manquants, et n'utiliser que des pièces approuvées par le fabricant.
 - Serrez fermement les fixations et utilisez uniquement les outils fournis ou recommandés.
 - Un mauvais montage, calage ou manutention incorrects pourraient affaiblir l'assemblage des pièces.
 - Tenir éloigné les jeunes enfants lors de l'assemblage. Présence de petites pièces susceptibles d'être ingérées.
 - Il convient que tous les dispositifs d'assemblage soient toujours convenablement serrés et régulièrement vérifiés, et resserrés, si nécessaire.
 - Ne pas déplacer un mobilier chargé.
 - Mobilier non prévu pour être remonté.
 - Si des pièces du fauteuil sont endommagées ou usées, ne plus l'utiliser et le remplacer.
 - **ATTENTION!** Ne pas utiliser ce siège pour des personnes souffrant d'un handicap physique et nécessitant la position assise continue et fréquente. Ce siège ne doit être utilisé que dans le cadre du loisir ou de la relaxation. Ce siège ne répond pas aux normes en vigueur du matériel médical.
 - Sur les chaises avec vérin à gaz, le remplacement ou la réparation du vérin à gaz doit être effectué par une personne qualifiée.
 - Sur les chaises avec système d'inclinaison, une inclinaison au-delà de 120° n'est pas considérée comme une utilisation normale du produit. Veuillez noter le risque de basculement vers l'arrière.
 - Sur les chaises, fauteuils et canapés avec accoudoirs, l'accoudoir n'est ni une table ni un siège : ne vous asseyez donc pas dessus.
- IT:** → **IMPORTANTE:** Prima di cominciare, questo mobile richiede da assemblare. Leggere attentamente le istruzioni di montaggio e conservarle per riferimenti futuri.
- Questo mobile è destinato all'uso domestico.
 - Verificare la presenza e lo stato dei dispositivi di fissaggio e dei componenti prima di iniziare il montaggio.
 - Non montare né utilizzare il mobile se ci sono pezzi rotti, danneggiati o mancanti. Utilizzare solo componenti approvati dal produttore.
 - Serrare saldamente i dispositivi di fissaggio e utilizzare solo gli utensili forniti o raccomandati.
 - Un montaggio, rinforzo o manipolazione scorretti possono indebolire la struttura.
 - Tenere i bambini lontani durante il montaggio. Il prodotto contiene piccole parti che potrebbero essere ingerite.
 - Si raccomanda di verificare regolarmente il corretto serraggio dei dispositivi di assemblaggio; serrarli se necessario.
 - Non spostare un mobile carico.
 - Il mobile non è progettato per essere smontato e rimontato.
 - Se dei componenti della poltrona sono danneggiati o usurati, non utilizzarla più e sostituirla.
 - **ATTENZIONE!** Questo prodotto non deve essere usata da persone con disabilità fisica e che devono rimanere sedute in modo continuo e frequente. Questo prodotto deve essere utilizzato esclusivamente per il relax e il tempo libero. Questo prodotto non soddisfa i requisiti in vigore per i materiali medici.
 - Nelle sedie con alzata a gas, la sostituzione o riparazione del meccanismo a gas deve essere effettuata da una persona qualificata.
 - Nelle sedie con sistema di inclinazione, un'inclinazione superiore a 120° non è considerata un uso normale del prodotto. Prestare attenzione al rischio di ribaltamento all'indietro.
 - Nelle sedie, poltrone e divani con braccioli, il bracciolo non è né un tavolo né un sedile: quindi non sedersi sopra.

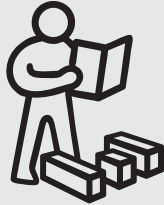

- PT:** → **IMPORTANTE:** Antes de começar, este móvel requer montagem. Leia atentamente as instruções e guarde-as para futuras consultas.
- Este móvel é para uso doméstico.
 - Verifique se possui todos os parafusos e peças antes de iniciar a montagem.
 - Não monte nem utilize o móvel se houver peças partidas, danificadas ou em falta. Utilize apenas peças aprovadas pelo fabricante.
 - Aperte bem todas as fixações e utilize apenas as ferramentas fornecidas ou recomendadas.
 - Montagem, reforço ou manuseio incorretos podem enfraquecer a estrutura.
 - Mantenha as crianças afastadas durante a montagem. O produto contém peças pequenas que podem ser ingeridas.
 - Todas as uniões devem ser apertadas adequadamente e verificadas periodicamente, reapertando-as se necessário.
 - Não mova o móvel quando estiver carregado.
 - O móvel não foi projetado para ser remontado.
 - Se partes da cadeira ficarem danificadas ou gastas, pare de a usar e substitua-a.
 - **AVISO!** Este assento não deverá ser usado por pessoas que sofram de deficiências físicas e que precisem de uma posição sentada contínua e frequente. Este produto deverá ser usado para lazer e relaxamento. Este produto não se encontra em conformidade com as normas em vigor para material médico.
 - Em cadeiras com elevação a gás, a substituição ou reparação do mecanismo a gás deve ser feita por uma pessoa qualificada.
 - Em cadeiras com sistema de inclinação, inclinar além de 120° não é considerado um uso normal do produto. Tenha atenção ao risco de tombamento para trás.
 - Em cadeiras, poltronas e sofás com braços, o braço não é uma mesa nem um assento: portanto, não se sente sobre ele.
- DE:** → **WICHTIG:** Vor dem Beginn muss dieses Möbelstück montiert werden. Lesen Sie die Montageanleitung sorgfältig durch und bewahren Sie sie für spätere Nachschlagezwecke auf.
- Dieses Möbel ist für den Hausgebrauch bestimmt.
 - Überprüfen Sie, ob alle Schrauben und Teile vorhanden sind, bevor Sie mit der Montage beginnen.
 - Montieren oder benutzen Sie das Möbel nicht, wenn Teile beschädigt, defekt oder fehlend sind. Verwenden Sie nur vom Hersteller zugelassene Teile.
 - Ziehen Sie alle Befestigungen fest an und verwenden Sie nur die mitgelieferten oder empfohlenen Werkzeuge.
 - Eine unsachgemäße Montage, Abstützung oder Handhabung kann die Stabilität beeinträchtigen.
 - Halten Sie Kinder während der Montage fern. Das Produkt enthält Kleinteile, die verschluckt werden könnten.
 - Alle Verbindungen müssen fest angezogen und regelmäßig überprüft und bei Bedarf nachgezogen werden.
 - Bewegen Sie keine Möbelstücke, die beladen sind.
 - Das Möbelstück ist nicht für eine erneute Demontage und Montage vorgesehen.
 - Verwenden Sie den Sessel nicht mehr und ersetzen Sie ihn, falls Teile des Sessels beschädigt oder abgenutzt sind.
 - **ACHTUNG!** Diesen Sitz nicht für Personen mit körperlichen Behinderungen verwenden, die kontinuierlich oder häufig sitzen müssen. Dieser Sitz darf nur zur Erholung oder Entspannung verwendet werden. Dieser Sitz entspricht nicht den geltenden Normen für medizinische Geräte.
 - Bei Stühlen mit Gasfeder muss der Austausch oder die Reparatur der Gasfeder von einer qualifizierten Person durchgeführt werden.
 - Bei Stühlen mit Neigungssystem gilt eine Neigung über 120° nicht als bestimmungsgemäßer Gebrauch des Produkts. Bitte beachten Sie die Kippgefahr nach hinten.
 - Bei Stühlen, Sesseln und Sofas mit Armlehnen gilt: Die Armlehne ist weder ein Tisch noch ein Sitzplatz – setzen Sie sich daher nicht darauf.



ES: → El montaje requiere de una persona.
→ Verifique las herramientas necesarias para el montaje. Las herramientas no están incluidas.
→ No utilizar herramientas eléctricas.

EN: → Assembly requires one person.
→ Check which tools are needed for assembly. Tools are not included.
→ Do not use power tools.

FR: → Le montage nécessite une seule personne.
→ Vérifiez quels outils sont nécessaires pour le montage. Les outils ne sont pas inclus.
→ N'utilisez pas d'outils électriques.

IT: → Il montaggio richiede una sola persona.
→ Verificare quali strumenti sono necessari per il montaggio. Gli strumenti non sono inclusi.
→ Non utilizzare utensili elettrici.

PT: → A montagem requer apenas uma pessoa.
→ Verifique quais ferramentas são necessárias para a montagem. As ferramentas não estão incluídas.
→ Não utilize ferramentas elétricas.

DE: → Für die Montage wird nur eine Person benötigt.
→ Prüfen Sie, welche Werkzeuge für die Montage erforderlich sind. Werkzeuge sind nicht im Lieferumfang enthalten.
→ Keine Elektrowerkzeuge verwenden.



ES: **Composición del producto**
Espuma, tela y metal.

EN: **Product Composition**
Foam, fabric and metal.

FR: **Composition du produit**
Mousse, tissu et métal.

IT: **Composizione del prodotto**
Schiuma, tessuto e metallo.

PT: **Composição do produto**
Espuma, tecido e metal.

DE: **Produktzusammensetzung**
Schaumstoff, Stoff und Metall.



4PC / 1CTN

Caja Box Colis	Tamaño de la caja Box dimensions Dimensions colis	Peso neto Net weight Podis net	Peso bruto Gross weight Podis brut
1/1	85*75*53.5cm	26kg	20.4kg



ES: Peso máximo recomendado.
EN: Maximum weight recommended.
FR: Poids maximum recommandé.

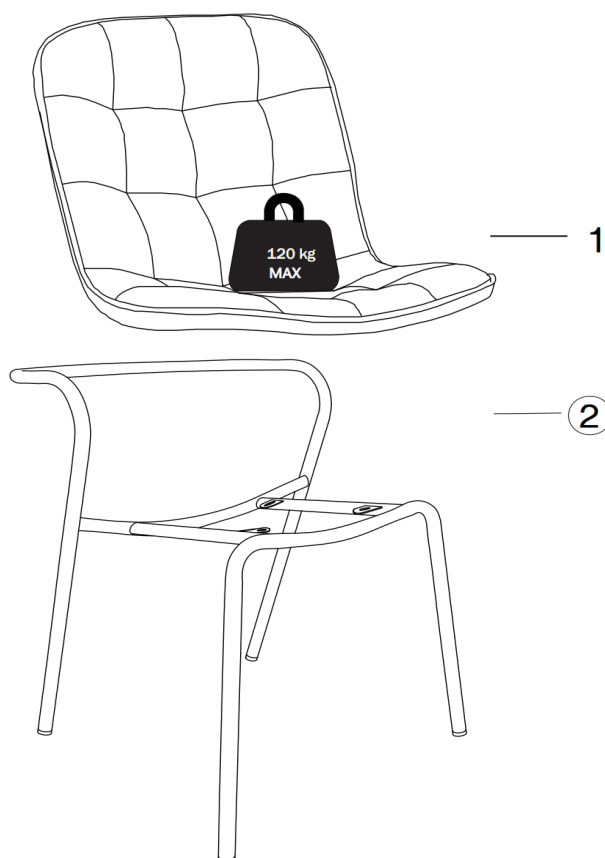

Caja-Box-Colis 1/1



Piece 01 x 1 un.
Piece 02 x 1 un.

Herrajes Hoja de montaje
Hardware Assembly sheet
Quincaillerie Notice de montage

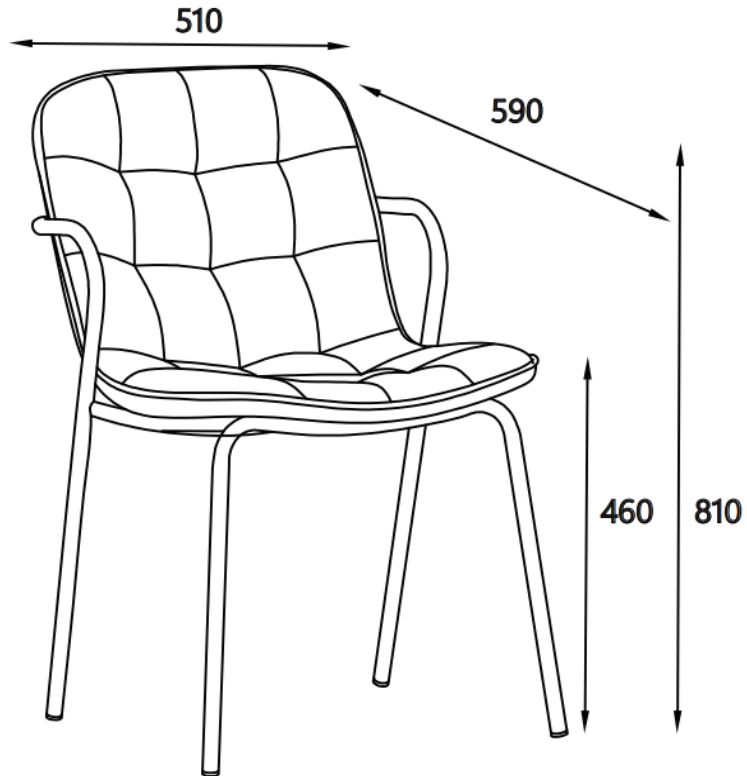

Medidas - Measures - Mesures



Listado de piezas - Parts list - Composants

1		1 PC	2		1 PC			
---	---	------	---	---	------	--	--	--

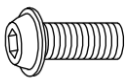
Herrajes - Hardware - Quincaillerie

A	 M5	1 PC	B	 M6 X 20	4 PCS	C	 M6x16	4 PCS
---	---	------	---	--	-------	---	--	-------

Herrajes - Hardware - Quincaillerie

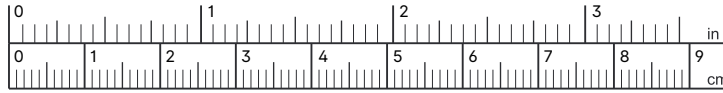

B x 4 ud.

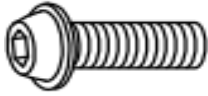

M6 X 20



ES: Atornille con cuidado. Forzar el ajuste puede dañar el mueble.

EN: Screw carefully. Forcing the fit may damage the furniture.

FR: Vissez avec précaution. Forcer l'ajustement peut endommager le meuble.



1



A x 1 ud.



B x 4 ud.



C x 4 ud.

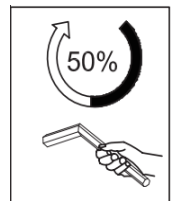
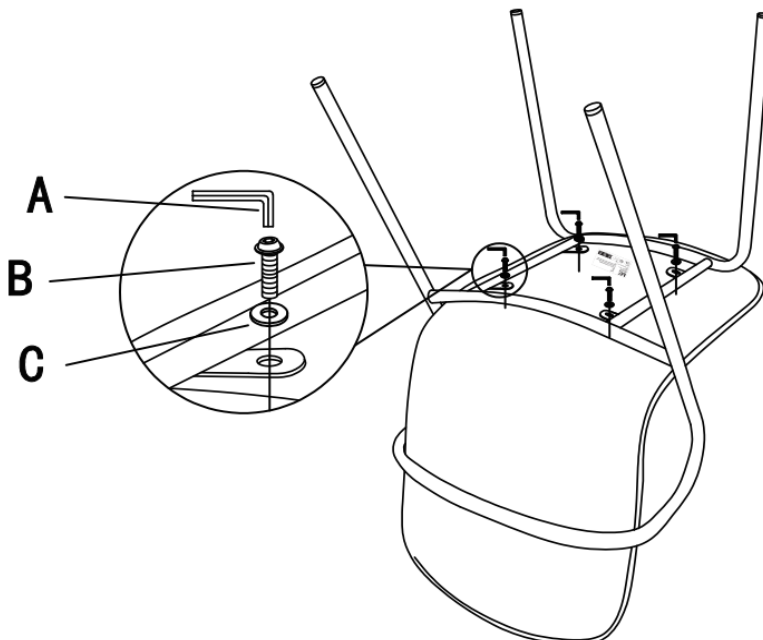

2



A x 1 ud.



B x 4 ud.



C x 4 ud.



100%



ES: Después de que todas las partes hayan sido fijadas con los tornillos, poner la silla sobre una superficie plana y nivelarla. Finalmente apretar todos los tornillos al 100%.

EN: After having fixed all pieces, put the chair on a plain surface and level it. After that, you can tighten all the screws at 100%.

FR: Après avoir monté toutes les pièces de la chaise, mettez la chaise sur une surface plane pour la niveler, puis finalement serrez toutes les vis 100%.

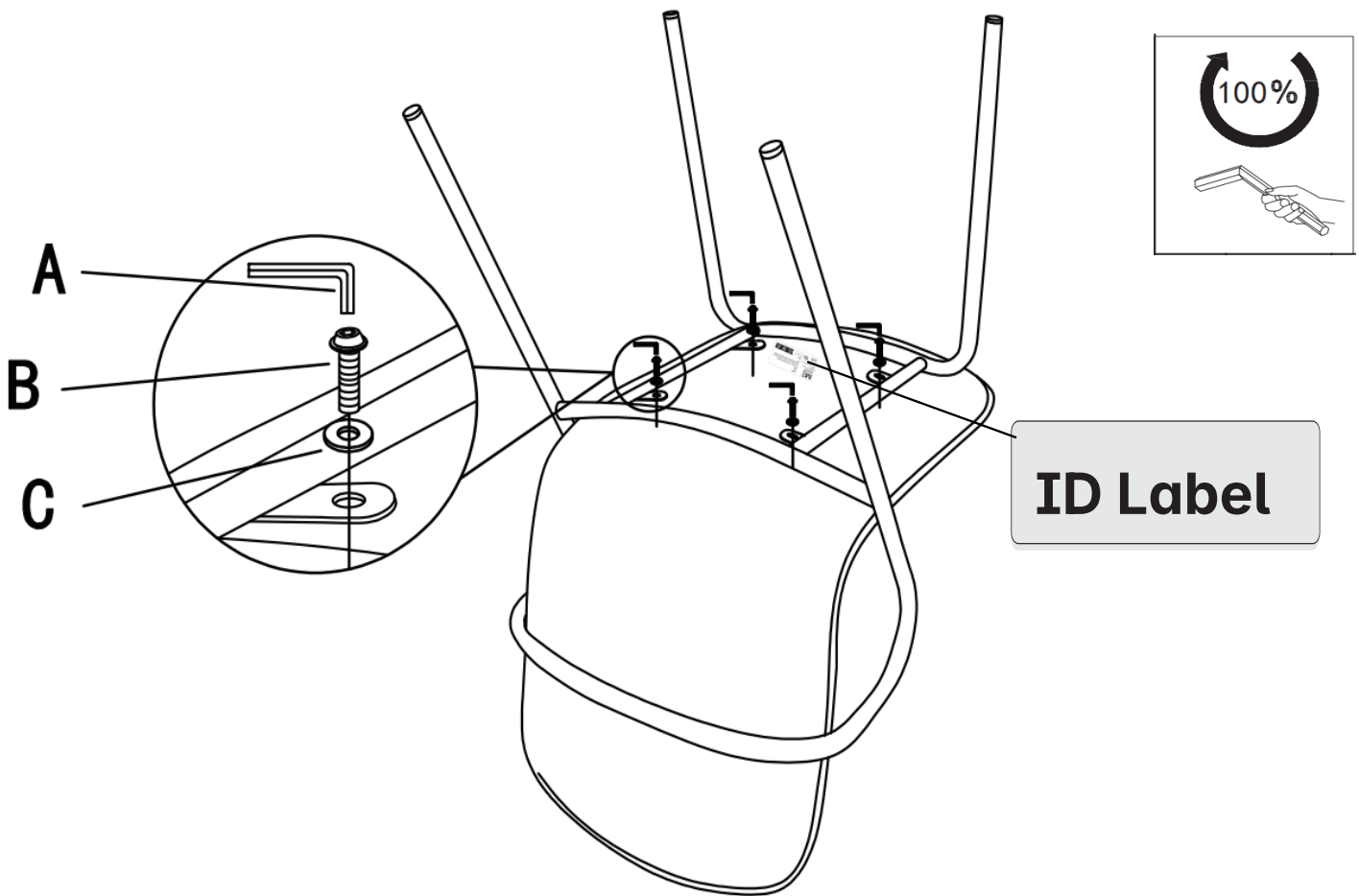



Consejos de montaje

1. Lea atentamente las instrucciones de montaje.
2. Identifique los componentes del mueble.
3. Agrupe y revise la tornillería.
4. Use las herramientas necesarias.
5. Prepare una zona de montaje.
6. Monte el mueble.



Consejos de mantenimiento y limpieza

- Nunca fuerce las uniones.
- Apriete los tornillos después de un tiempo de uso.
- Conserve el manual de montaje; si falta alguna pieza, es la forma más fácil de contactar con la tienda.
- No utilice productos abrasivos, lana de acero ni disolventes.
- No moje el producto.
- Quite cuidadosamente el polvo.
- Utilice un paño ligeramente humedecido.

Instrucciones de mantenimiento
Paño suave ligeramente húmedo
Agua con jabón
Agua con detergente
Esponja anti-rayaduras
Mantenimiento específico del fabricante

Materiales												
Madera maciza acelitada	Madera encerada	Madera barnizada o teñida	Panel de madera con papel decorativo	Paneles recubiertos de melamina	Superficie lacada	Piedras	Cuero	Metal	Plástico	Textil	Textil revestido (PU, PVC)	Producto con partes eléctricas
<input type="checkbox"/>	<input type="checkbox"/>	<input type="checkbox"/>	<input type="checkbox"/>	<input type="checkbox"/>	<input type="checkbox"/>	<input type="checkbox"/>	<input type="checkbox"/>	<input type="checkbox"/>	<input type="checkbox"/>	<input type="checkbox"/>	<input type="checkbox"/>	<input type="checkbox"/>
<input type="checkbox"/>	<input type="checkbox"/>	<input type="checkbox"/>	<input type="checkbox"/>	<input type="checkbox"/>	<input type="checkbox"/>	<input type="checkbox"/>	<input type="checkbox"/>	<input type="checkbox"/>	<input type="checkbox"/>	<input type="checkbox"/>	<input type="checkbox"/>	<input type="checkbox"/>
<input type="checkbox"/>	<input type="checkbox"/>	<input type="checkbox"/>	<input type="checkbox"/>	<input type="checkbox"/>	<input type="checkbox"/>	<input type="checkbox"/>	<input type="checkbox"/>	<input type="checkbox"/>	<input type="checkbox"/>	<input type="checkbox"/>	<input type="checkbox"/>	<input type="checkbox"/>
<input type="checkbox"/>	<input type="checkbox"/>	<input type="checkbox"/>	<input type="checkbox"/>	<input type="checkbox"/>	<input type="checkbox"/>	<input type="checkbox"/>	<input type="checkbox"/>	<input type="checkbox"/>	<input type="checkbox"/>	<input type="checkbox"/>	<input type="checkbox"/>	<input type="checkbox"/>

⚠ Advertencias ⚠
Antes de cualquier mantenimiento, limpie el polvo con cuidado
Cualquier mancha debe limpiarse rápidamente
No utilice productos abrasivos (polvo, lana de acero)
No utilice disolventes
No mojar
No limpiar con hidrolimpiadora (productos de exterior)

<input type="checkbox"/>	<input type="checkbox"/>	<input type="checkbox"/>	<input type="checkbox"/>	<input type="checkbox"/>	<input type="checkbox"/>	<input type="checkbox"/>	<input type="checkbox"/>	<input type="checkbox"/>	<input type="checkbox"/>	<input type="checkbox"/>	<input type="checkbox"/>	<input type="checkbox"/>
<input type="checkbox"/>	<input type="checkbox"/>	<input type="checkbox"/>	<input type="checkbox"/>	<input type="checkbox"/>	<input type="checkbox"/>	<input type="checkbox"/>	<input type="checkbox"/>	<input type="checkbox"/>	<input type="checkbox"/>	<input type="checkbox"/>	<input type="checkbox"/>	<input type="checkbox"/>
<input type="checkbox"/>	<input type="checkbox"/>	<input type="checkbox"/>	<input type="checkbox"/>	<input type="checkbox"/>	<input type="checkbox"/>	<input type="checkbox"/>	<input type="checkbox"/>	<input type="checkbox"/>	<input type="checkbox"/>	<input type="checkbox"/>	<input type="checkbox"/>	<input type="checkbox"/>
<input type="checkbox"/>	<input type="checkbox"/>	<input type="checkbox"/>	<input type="checkbox"/>	<input type="checkbox"/>	<input type="checkbox"/>	<input type="checkbox"/>	<input type="checkbox"/>	<input type="checkbox"/>	<input type="checkbox"/>	<input type="checkbox"/>	<input type="checkbox"/>	<input type="checkbox"/>
<input type="checkbox"/>	<input type="checkbox"/>	<input type="checkbox"/>	<input type="checkbox"/>	<input type="checkbox"/>	<input type="checkbox"/>	<input type="checkbox"/>	<input type="checkbox"/>	<input type="checkbox"/>	<input type="checkbox"/>	<input type="checkbox"/>	<input type="checkbox"/>	<input type="checkbox"/>

Información específica
Consulte la información adicional adjunta al producto.

<input type="checkbox"/>	<input type="checkbox"/>	<input type="checkbox"/>	<input type="checkbox"/>	<input type="checkbox"/>	<input type="checkbox"/>	<input type="checkbox"/>	<input type="checkbox"/>	<input type="checkbox"/>	<input type="checkbox"/>	<input type="checkbox"/>	<input type="checkbox"/>	<input type="checkbox"/>
--------------------------	--------------------------	--------------------------	--------------------------	--------------------------	--------------------------	--------------------------	--------------------------	--------------------------	--------------------------	--------------------------	--------------------------	--------------------------



Assembly advices

1. Carefully read the assembly instruction.
2. Identify the components of the furniture.
3. Group and check the hardware.
4. Use the required tools.
5. Create an assembly zone.
6. Make the assembly.



Maintenance and cleaning advices

- Never force the connections.
- Tighten the screws after a period of use.
- Keep the assembly manual; if a part is missing, it is the easiest way to contact the store.
- Do not use abrasive powders, steel wool or solvents.
- Do not wet.
- Carefully remove dust.
- Use a slightly damp cloth.

Maintenance instructions

Slightly damp soft cloth
Soapy water
Water with detergent
Anti-scratch scouring sponge
Manufacturer specific maintenance

Materials												
Solid wood oiled	Waxed wood	Varnished or stained wood	Wood panel covered with decorative paper	Melamine covered panels	Lacquered surface	Stones	Leather	Metal	Plastic	Textile	Enducted textile (PU, PVC)	Product with electrical parts

<input type="checkbox"/>	<input type="checkbox"/>	<input type="checkbox"/>	<input type="checkbox"/>	<input type="checkbox"/>	<input type="checkbox"/>	<input type="checkbox"/>	<input type="checkbox"/>	<input type="checkbox"/>	<input type="checkbox"/>	<input type="checkbox"/>	<input type="checkbox"/>	<input type="checkbox"/>
<input type="checkbox"/>	<input type="checkbox"/>	<input type="checkbox"/>	<input type="checkbox"/>	<input type="checkbox"/>	<input type="checkbox"/>	<input type="checkbox"/>	<input type="checkbox"/>	<input type="checkbox"/>	<input type="checkbox"/>	<input type="checkbox"/>	<input type="checkbox"/>	<input type="checkbox"/>
<input type="checkbox"/>	<input type="checkbox"/>	<input type="checkbox"/>	<input type="checkbox"/>	<input type="checkbox"/>	<input type="checkbox"/>	<input type="checkbox"/>	<input type="checkbox"/>	<input type="checkbox"/>	<input type="checkbox"/>	<input type="checkbox"/>	<input type="checkbox"/>	<input type="checkbox"/>
<input type="checkbox"/>	<input type="checkbox"/>	<input type="checkbox"/>	<input type="checkbox"/>	<input type="checkbox"/>	<input type="checkbox"/>	<input type="checkbox"/>	<input type="checkbox"/>	<input type="checkbox"/>	<input type="checkbox"/>	<input type="checkbox"/>	<input type="checkbox"/>	<input type="checkbox"/>
<input type="checkbox"/>	<input type="checkbox"/>	<input type="checkbox"/>	<input type="checkbox"/>	<input type="checkbox"/>	<input type="checkbox"/>	<input type="checkbox"/>	<input type="checkbox"/>	<input type="checkbox"/>	<input type="checkbox"/>	<input type="checkbox"/>	<input type="checkbox"/>	<input type="checkbox"/>

Warning

Before any maintenance, clean the dust carefully
Any stain should be cleaned quickly
Never use an abrasive product (powder, steel wool)
Never use solvent
Do not wet
Do not clean with high pressure cleaner (outdoor products)

<input type="checkbox"/>	<input type="checkbox"/>	<input type="checkbox"/>	<input type="checkbox"/>	<input type="checkbox"/>	<input type="checkbox"/>	<input type="checkbox"/>	<input type="checkbox"/>	<input type="checkbox"/>	<input type="checkbox"/>	<input type="checkbox"/>	<input type="checkbox"/>	<input type="checkbox"/>
<input type="checkbox"/>	<input type="checkbox"/>	<input type="checkbox"/>	<input type="checkbox"/>	<input type="checkbox"/>	<input type="checkbox"/>	<input type="checkbox"/>	<input type="checkbox"/>	<input type="checkbox"/>	<input type="checkbox"/>	<input type="checkbox"/>	<input type="checkbox"/>	<input type="checkbox"/>
<input type="checkbox"/>	<input type="checkbox"/>	<input type="checkbox"/>	<input type="checkbox"/>	<input type="checkbox"/>	<input type="checkbox"/>	<input type="checkbox"/>	<input type="checkbox"/>	<input type="checkbox"/>	<input type="checkbox"/>	<input type="checkbox"/>	<input type="checkbox"/>	<input type="checkbox"/>
<input type="checkbox"/>	<input type="checkbox"/>	<input type="checkbox"/>	<input type="checkbox"/>	<input type="checkbox"/>	<input type="checkbox"/>	<input type="checkbox"/>	<input type="checkbox"/>	<input type="checkbox"/>	<input type="checkbox"/>	<input type="checkbox"/>	<input type="checkbox"/>	<input type="checkbox"/>
<input type="checkbox"/>	<input type="checkbox"/>	<input type="checkbox"/>	<input type="checkbox"/>	<input type="checkbox"/>	<input type="checkbox"/>	<input type="checkbox"/>	<input type="checkbox"/>	<input type="checkbox"/>	<input type="checkbox"/>	<input type="checkbox"/>	<input type="checkbox"/>	<input type="checkbox"/>

Specific information

Check extra information attached on the product

<input type="checkbox"/>	<input type="checkbox"/>	<input type="checkbox"/>	<input type="checkbox"/>	<input type="checkbox"/>	<input type="checkbox"/>	<input type="checkbox"/>	<input type="checkbox"/>	<input type="checkbox"/>	<input type="checkbox"/>	<input type="checkbox"/>	<input type="checkbox"/>	<input type="checkbox"/>
--------------------------	--------------------------	--------------------------	--------------------------	--------------------------	--------------------------	--------------------------	--------------------------	--------------------------	--------------------------	--------------------------	--------------------------	--------------------------



Conseils de montage

1. Lisez attentivement les instructions de montage.
2. Identifiez les composants du meuble.
3. Regroupez et vérifiez la quincaillerie.
4. Utilisez les outils nécessaires.
5. Préparez une zone de montage.
6. Effectuez le montage.



Conseils d'entretien et de nettoyage

- Ne forcez jamais les connexions.
- Resserrez les vis après une période d'utilisation.
- Conservez le manuel de montage ; en cas de pièce manquante, c'est le moyen le plus simple de contacter le magasin.
- N'utilisez pas de poudres abrasives, laine d'acier ou solvants.
- Ne mouillez pas le produit.
- Enlevez délicatement la poussière.
- Utilisez un chiffon légèrement humide.

Instructions d'entretien	
Chiffon doux légèrement humide	<input type="checkbox"/>
Eau savonneuse	<input type="checkbox"/>
Eau avec détergent	<input type="checkbox"/>
Éponge non abrasive	<input type="checkbox"/>
Entretien spécifique du fabricant	<input type="checkbox"/>

Matériaux												
Bois massif huilé	Bois ciré	Bois verni ou teinté	Panneau bois avec papier décoratif	Panneaux revêtus de mélamine	Surface laquée	Pierres	Cuir	Métal	Plastique	Tissu	Tissu enduit (PU, PVC)	Produit avec éléments électriques

<input type="checkbox"/>	<input type="checkbox"/>	<input type="checkbox"/>	<input type="checkbox"/>	<input type="checkbox"/>	<input type="checkbox"/>	<input type="checkbox"/>	<input type="checkbox"/>	<input type="checkbox"/>	<input type="checkbox"/>	<input type="checkbox"/>	<input type="checkbox"/>	<input type="checkbox"/>
<input type="checkbox"/>	<input type="checkbox"/>	<input type="checkbox"/>	<input type="checkbox"/>	<input type="checkbox"/>	<input type="checkbox"/>	<input type="checkbox"/>	<input type="checkbox"/>	<input type="checkbox"/>	<input type="checkbox"/>	<input type="checkbox"/>	<input type="checkbox"/>	<input type="checkbox"/>
<input type="checkbox"/>	<input type="checkbox"/>	<input type="checkbox"/>	<input type="checkbox"/>	<input type="checkbox"/>	<input type="checkbox"/>	<input type="checkbox"/>	<input type="checkbox"/>	<input type="checkbox"/>	<input type="checkbox"/>	<input type="checkbox"/>	<input type="checkbox"/>	<input type="checkbox"/>
<input type="checkbox"/>	<input type="checkbox"/>	<input type="checkbox"/>	<input type="checkbox"/>	<input type="checkbox"/>	<input type="checkbox"/>	<input type="checkbox"/>	<input type="checkbox"/>	<input type="checkbox"/>	<input type="checkbox"/>	<input type="checkbox"/>	<input type="checkbox"/>	<input type="checkbox"/>
<input type="checkbox"/>	<input type="checkbox"/>	<input type="checkbox"/>	<input type="checkbox"/>	<input type="checkbox"/>	<input type="checkbox"/>	<input type="checkbox"/>	<input type="checkbox"/>	<input type="checkbox"/>	<input type="checkbox"/>	<input type="checkbox"/>	<input type="checkbox"/>	<input type="checkbox"/>

⚠ Avertissements ⚠	
Avant tout entretien, enlever la poussière avec soin	<input type="checkbox"/>
Toute tache doit être nettoyée rapidement	<input type="checkbox"/>
N'utilisez jamais de produit abrasif (poudre, laine d'acier)	<input type="checkbox"/>
N'utilisez jamais de solvant	<input type="checkbox"/>
Ne pas mouiller	<input type="checkbox"/>
Ne pas nettoyer avec un nettoyeur haute pression (produits extérieurs)	<input type="checkbox"/>

<input type="checkbox"/>	<input type="checkbox"/>	<input type="checkbox"/>	<input type="checkbox"/>	<input type="checkbox"/>	<input type="checkbox"/>	<input type="checkbox"/>	<input type="checkbox"/>	<input type="checkbox"/>	<input type="checkbox"/>	<input type="checkbox"/>	<input type="checkbox"/>	<input type="checkbox"/>
<input type="checkbox"/>	<input type="checkbox"/>	<input type="checkbox"/>	<input type="checkbox"/>	<input type="checkbox"/>	<input type="checkbox"/>	<input type="checkbox"/>	<input type="checkbox"/>	<input type="checkbox"/>	<input type="checkbox"/>	<input type="checkbox"/>	<input type="checkbox"/>	<input type="checkbox"/>
<input type="checkbox"/>	<input type="checkbox"/>	<input type="checkbox"/>	<input type="checkbox"/>	<input type="checkbox"/>	<input type="checkbox"/>	<input type="checkbox"/>	<input type="checkbox"/>	<input type="checkbox"/>	<input type="checkbox"/>	<input type="checkbox"/>	<input type="checkbox"/>	<input type="checkbox"/>
<input type="checkbox"/>	<input type="checkbox"/>	<input type="checkbox"/>	<input type="checkbox"/>	<input type="checkbox"/>	<input type="checkbox"/>	<input type="checkbox"/>	<input type="checkbox"/>	<input type="checkbox"/>	<input type="checkbox"/>	<input type="checkbox"/>	<input type="checkbox"/>	<input type="checkbox"/>
<input type="checkbox"/>	<input type="checkbox"/>	<input type="checkbox"/>	<input type="checkbox"/>	<input type="checkbox"/>	<input type="checkbox"/>	<input type="checkbox"/>	<input type="checkbox"/>	<input type="checkbox"/>	<input type="checkbox"/>	<input type="checkbox"/>	<input type="checkbox"/>	<input type="checkbox"/>
<input type="checkbox"/>	<input type="checkbox"/>	<input type="checkbox"/>	<input type="checkbox"/>	<input type="checkbox"/>	<input type="checkbox"/>	<input type="checkbox"/>	<input type="checkbox"/>	<input type="checkbox"/>	<input type="checkbox"/>	<input type="checkbox"/>	<input type="checkbox"/>	<input type="checkbox"/>

Informations spécifiques	
Consultez les informations supplémentaires jointes au produit.	<input type="checkbox"/>

<input type="checkbox"/>	<input type="checkbox"/>	<input type="checkbox"/>	<input type="checkbox"/>	<input type="checkbox"/>	<input type="checkbox"/>	<input type="checkbox"/>	<input type="checkbox"/>	<input type="checkbox"/>	<input type="checkbox"/>	<input type="checkbox"/>	<input type="checkbox"/>	<input type="checkbox"/>
--------------------------	--------------------------	--------------------------	--------------------------	--------------------------	--------------------------	--------------------------	--------------------------	--------------------------	--------------------------	--------------------------	--------------------------	--------------------------



Consigli di montaggio

1. Leggere attentamente le istruzioni di montaggio.
2. Identificare i componenti del mobile.
3. Raggruppare e controllare la ferramenta.
4. Utilizzare gli strumenti necessari.
5. Creare una zona per il montaggio.
6. Eseguire il montaggio.



Consigli per la manutenzione e la pulizia

- Non forzare mai i collegamenti.
- Stringere le viti dopo un certo periodo d'uso.
- Conservare il manuale di montaggio; se manca un pezzo, è il modo più semplice per contattare il negozio.
- Non utilizzare polveri abrasive, lana d'acciaio o solventi.
- Non bagnare il prodotto.
- Rimuovere delicatamente la polvere.
- Usare un panno leggermente umido.

Istruzioni per la manutenzione	
Panno morbido leggermente umido	<input type="checkbox"/>
Acqua saponata	<input type="checkbox"/>
Acqua con detergente	<input type="checkbox"/>
Spugna antigraffio	<input type="checkbox"/>
Manutenzione specifica del produttore	<input type="checkbox"/>

Materiali												
Legno massiccio oliato	Legno cerato	Legno verniciato o tinto	Pannello in legno con carta decorativa	Pannelli rivestiti in melamina	Superficie laccata	Pietre	Pelle	Metallo	Plastica	Tessuto	Tessuto spalmato (PU, PVC)	Prodotto con parti elettriche

<input type="checkbox"/>	<input type="checkbox"/>	<input type="checkbox"/>	<input type="checkbox"/>	<input type="checkbox"/>	<input type="checkbox"/>	<input type="checkbox"/>	<input type="checkbox"/>	<input type="checkbox"/>	<input type="checkbox"/>	<input type="checkbox"/>	<input type="checkbox"/>	<input type="checkbox"/>
<input type="checkbox"/>	<input type="checkbox"/>	<input type="checkbox"/>	<input type="checkbox"/>	<input type="checkbox"/>	<input type="checkbox"/>	<input type="checkbox"/>	<input type="checkbox"/>	<input type="checkbox"/>	<input type="checkbox"/>	<input type="checkbox"/>	<input type="checkbox"/>	<input type="checkbox"/>
<input type="checkbox"/>	<input type="checkbox"/>	<input type="checkbox"/>	<input type="checkbox"/>	<input type="checkbox"/>	<input type="checkbox"/>	<input type="checkbox"/>	<input type="checkbox"/>	<input type="checkbox"/>	<input type="checkbox"/>	<input type="checkbox"/>	<input type="checkbox"/>	<input type="checkbox"/>
<input type="checkbox"/>	<input type="checkbox"/>	<input type="checkbox"/>	<input type="checkbox"/>	<input type="checkbox"/>	<input type="checkbox"/>	<input type="checkbox"/>	<input type="checkbox"/>	<input type="checkbox"/>	<input type="checkbox"/>	<input type="checkbox"/>	<input type="checkbox"/>	<input type="checkbox"/>
<input type="checkbox"/>	<input type="checkbox"/>	<input type="checkbox"/>	<input type="checkbox"/>	<input type="checkbox"/>	<input type="checkbox"/>	<input type="checkbox"/>	<input type="checkbox"/>	<input type="checkbox"/>	<input type="checkbox"/>	<input type="checkbox"/>	<input type="checkbox"/>	<input type="checkbox"/>

⚠ Avvertenze ⚠	
Prima di ogni manutenzione, rimuovere la polvere con cura	<input type="checkbox"/>
Qualsiasi macchia deve essere pulita subito	<input type="checkbox"/>
Non usare mai prodotti abrasivi (polvere, lana d'acciaio)	<input type="checkbox"/>
Non usare solventi	<input type="checkbox"/>
Non bagnare	<input type="checkbox"/>
Non pulire con idropulitrice (prodotti da esterno)	<input type="checkbox"/>

<input type="checkbox"/>	<input type="checkbox"/>	<input type="checkbox"/>	<input type="checkbox"/>	<input type="checkbox"/>	<input type="checkbox"/>	<input type="checkbox"/>	<input type="checkbox"/>	<input type="checkbox"/>	<input type="checkbox"/>	<input type="checkbox"/>	<input type="checkbox"/>	<input type="checkbox"/>
<input type="checkbox"/>	<input type="checkbox"/>	<input type="checkbox"/>	<input type="checkbox"/>	<input type="checkbox"/>	<input type="checkbox"/>	<input type="checkbox"/>	<input type="checkbox"/>	<input type="checkbox"/>	<input type="checkbox"/>	<input type="checkbox"/>	<input type="checkbox"/>	<input type="checkbox"/>
<input type="checkbox"/>	<input type="checkbox"/>	<input type="checkbox"/>	<input type="checkbox"/>	<input type="checkbox"/>	<input type="checkbox"/>	<input type="checkbox"/>	<input type="checkbox"/>	<input type="checkbox"/>	<input type="checkbox"/>	<input type="checkbox"/>	<input type="checkbox"/>	<input type="checkbox"/>
<input type="checkbox"/>	<input type="checkbox"/>	<input type="checkbox"/>	<input type="checkbox"/>	<input type="checkbox"/>	<input type="checkbox"/>	<input type="checkbox"/>	<input type="checkbox"/>	<input type="checkbox"/>	<input type="checkbox"/>	<input type="checkbox"/>	<input type="checkbox"/>	<input type="checkbox"/>
<input type="checkbox"/>	<input type="checkbox"/>	<input type="checkbox"/>	<input type="checkbox"/>	<input type="checkbox"/>	<input type="checkbox"/>	<input type="checkbox"/>	<input type="checkbox"/>	<input type="checkbox"/>	<input type="checkbox"/>	<input type="checkbox"/>	<input type="checkbox"/>	<input type="checkbox"/>

Informazioni specifiche	
Consultare le informazioni aggiuntive allegate al prodotto.	<input type="checkbox"/>

<input type="checkbox"/>	<input type="checkbox"/>	<input type="checkbox"/>	<input type="checkbox"/>	<input type="checkbox"/>	<input type="checkbox"/>	<input type="checkbox"/>	<input type="checkbox"/>	<input type="checkbox"/>	<input type="checkbox"/>	<input type="checkbox"/>	<input type="checkbox"/>	<input type="checkbox"/>
--------------------------	--------------------------	--------------------------	--------------------------	--------------------------	--------------------------	--------------------------	--------------------------	--------------------------	--------------------------	--------------------------	--------------------------	--------------------------



Conselhos de montagem

1. Leia atentamente as instruções de montagem.
2. Identifique os componentes do móvel.
3. Agrupe e verifique a ferragem.
4. Use as ferramentas necessárias.
5. Crie uma área para montagem.
6. Faça a montagem.



Conselhos de manutenção e limpeza

- Nunca force as ligações.
- Aperte os parafusos após algum tempo de uso.
- Guarde o manual de montagem; se faltar alguma peça, é a forma mais fácil de contactar a loja.
- Não use pós abrasivos, palha de aço ou solventes.
- Não molhe o produto.
- Remova cuidadosamente o pó.
- Use um pano ligeiramente húmido.

Instruções de manutenção

Pano macio ligeiramente húmido
Água com sabão
Água com detergente
Espanja anti-riscos
Manutenção específica do fabricante

Materiais												
Madeira maciça com óleo	Madeira encerada	Madeira envernizada ou tingida	Painel de madeira com papel decorativo	Painéis revestidos com melamina	Superfície lacada	Pedras	Couro	Metal	Plástico	Têxtil	Tecido revestido (PU, PVC)	Produto com partes elétricas

<input type="checkbox"/>	<input type="checkbox"/>	<input type="checkbox"/>	<input type="checkbox"/>	<input type="checkbox"/>	<input type="checkbox"/>	<input type="checkbox"/>	<input type="checkbox"/>	<input type="checkbox"/>	<input type="checkbox"/>	<input type="checkbox"/>	<input type="checkbox"/>	<input type="checkbox"/>
<input type="checkbox"/>	<input type="checkbox"/>	<input type="checkbox"/>	<input type="checkbox"/>	<input type="checkbox"/>	<input type="checkbox"/>	<input type="checkbox"/>	<input type="checkbox"/>	<input type="checkbox"/>	<input type="checkbox"/>	<input type="checkbox"/>	<input type="checkbox"/>	<input type="checkbox"/>
<input type="checkbox"/>	<input type="checkbox"/>	<input type="checkbox"/>	<input type="checkbox"/>	<input type="checkbox"/>	<input type="checkbox"/>	<input type="checkbox"/>	<input type="checkbox"/>	<input type="checkbox"/>	<input type="checkbox"/>	<input type="checkbox"/>	<input type="checkbox"/>	<input type="checkbox"/>
<input type="checkbox"/>	<input type="checkbox"/>	<input type="checkbox"/>	<input type="checkbox"/>	<input type="checkbox"/>	<input type="checkbox"/>	<input type="checkbox"/>	<input type="checkbox"/>	<input type="checkbox"/>	<input type="checkbox"/>	<input type="checkbox"/>	<input type="checkbox"/>	<input type="checkbox"/>

Advertências

Antes de qualquer manutenção, limpe cuidadosamente o pó
Qualquer mancha deve ser limpa rapidamente
Nunca use produtos abrasivos (pó, palha de aço)
Nunca use solventes
Não molhar
Não limpar com lavadora de alta pressão (produtos de exterior)

<input type="checkbox"/>	<input type="checkbox"/>	<input type="checkbox"/>	<input type="checkbox"/>	<input type="checkbox"/>	<input type="checkbox"/>	<input type="checkbox"/>	<input type="checkbox"/>	<input type="checkbox"/>	<input type="checkbox"/>	<input type="checkbox"/>	<input type="checkbox"/>	<input type="checkbox"/>
<input type="checkbox"/>	<input type="checkbox"/>	<input type="checkbox"/>	<input type="checkbox"/>	<input type="checkbox"/>	<input type="checkbox"/>	<input type="checkbox"/>	<input type="checkbox"/>	<input type="checkbox"/>	<input type="checkbox"/>	<input type="checkbox"/>	<input type="checkbox"/>	<input type="checkbox"/>
<input type="checkbox"/>	<input type="checkbox"/>	<input type="checkbox"/>	<input type="checkbox"/>	<input type="checkbox"/>	<input type="checkbox"/>	<input type="checkbox"/>	<input type="checkbox"/>	<input type="checkbox"/>	<input type="checkbox"/>	<input type="checkbox"/>	<input type="checkbox"/>	<input type="checkbox"/>
<input type="checkbox"/>	<input type="checkbox"/>	<input type="checkbox"/>	<input type="checkbox"/>	<input type="checkbox"/>	<input type="checkbox"/>	<input type="checkbox"/>	<input type="checkbox"/>	<input type="checkbox"/>	<input type="checkbox"/>	<input type="checkbox"/>	<input type="checkbox"/>	<input type="checkbox"/>
<input type="checkbox"/>	<input type="checkbox"/>	<input type="checkbox"/>	<input type="checkbox"/>	<input type="checkbox"/>	<input type="checkbox"/>	<input type="checkbox"/>	<input type="checkbox"/>	<input type="checkbox"/>	<input type="checkbox"/>	<input type="checkbox"/>	<input type="checkbox"/>	<input type="checkbox"/>

Informações específicas

Consulte as informações adicionais anexadas ao produto.

<input type="checkbox"/>	<input type="checkbox"/>	<input type="checkbox"/>	<input type="checkbox"/>	<input type="checkbox"/>	<input type="checkbox"/>	<input type="checkbox"/>	<input type="checkbox"/>	<input type="checkbox"/>	<input type="checkbox"/>	<input type="checkbox"/>	<input type="checkbox"/>	<input type="checkbox"/>
--------------------------	--------------------------	--------------------------	--------------------------	--------------------------	--------------------------	--------------------------	--------------------------	--------------------------	--------------------------	--------------------------	--------------------------	--------------------------



Montagehinweise

1. Lesen Sie die Montageanleitung sorgfältig durch.
2. Identifizieren Sie die Möbelteile.
3. Gruppieren und prüfen Sie die Beschläge.
4. Verwenden Sie das notwendige Werkzeug.
5. Richten Sie einen Montagebereich ein.
6. Führen Sie die Montage durch.



Hinweise zur Pflege und Reinigung

- Erzwingen Sie keine Verbindungen.
- Ziehen Sie die Schrauben nach einer gewissen Nutzungsdauer nach.
- Bewahren Sie die Montageanleitung auf; fehlt ein Teil, ist dies der einfachste Weg, das Geschäft zu kontaktieren.
- Verwenden Sie keine Scheuermittel, Stahlwolle oder Lösungsmittel.
- Nicht nass machen.
- Staub vorsichtig entfernen.
- Ein leicht feuchtes Tuch verwenden.

Materialien												
Massivholz geölt	Gewachstes Holz	Lackiertes oder gebeiztes Holz	Holzplatte mit Dekorpapier	Melaminbeschichtete Platten	Lackierte Oberfläche	Steine	Leder	Metal	Kunststoff	Textil	Beschichteter Stoff (PU, PVC)	Produkt mit elektrischen Teilen

Pflegehinweise
Weiches, leicht feuchtes Tuch
Seifenwasser
Wasser mit Reinigungsmittel
Kratzfreie Scheuerschwamm
Herstellerspezifische Pflege

<input type="checkbox"/>	<input type="checkbox"/>	<input type="checkbox"/>	<input type="checkbox"/>	<input type="checkbox"/>	<input type="checkbox"/>	<input type="checkbox"/>	<input type="checkbox"/>	<input type="checkbox"/>	<input type="checkbox"/>	<input type="checkbox"/>	<input type="checkbox"/>	<input type="checkbox"/>
<input type="checkbox"/>	<input type="checkbox"/>	<input type="checkbox"/>	<input type="checkbox"/>	<input type="checkbox"/>	<input type="checkbox"/>	<input type="checkbox"/>	<input type="checkbox"/>	<input type="checkbox"/>	<input type="checkbox"/>	<input type="checkbox"/>	<input type="checkbox"/>	<input type="checkbox"/>
<input type="checkbox"/>	<input type="checkbox"/>	<input type="checkbox"/>	<input type="checkbox"/>	<input type="checkbox"/>	<input type="checkbox"/>	<input type="checkbox"/>	<input type="checkbox"/>	<input type="checkbox"/>	<input type="checkbox"/>	<input type="checkbox"/>	<input type="checkbox"/>	<input type="checkbox"/>
<input type="checkbox"/>	<input type="checkbox"/>	<input type="checkbox"/>	<input type="checkbox"/>	<input type="checkbox"/>	<input type="checkbox"/>	<input type="checkbox"/>	<input type="checkbox"/>	<input type="checkbox"/>	<input type="checkbox"/>	<input type="checkbox"/>	<input type="checkbox"/>	<input type="checkbox"/>
<input type="checkbox"/>	<input type="checkbox"/>	<input type="checkbox"/>	<input type="checkbox"/>	<input type="checkbox"/>	<input type="checkbox"/>	<input type="checkbox"/>	<input type="checkbox"/>	<input type="checkbox"/>	<input type="checkbox"/>	<input type="checkbox"/>	<input type="checkbox"/>	<input type="checkbox"/>

Warnhinweise
Vor jeder Wartung Staub sorgfältig entfernen
Flecken sollten sofort entfernt werden
Keine scheuernden Produkte verwenden (Pulver, Stahlwolle)
Keine Lösungsmittel verwenden
Nicht nass machen
Nicht mit Hochdruckreiniger reinigen (für Außenprodukte)

<input type="checkbox"/>	<input type="checkbox"/>	<input type="checkbox"/>	<input type="checkbox"/>	<input type="checkbox"/>	<input type="checkbox"/>	<input type="checkbox"/>	<input type="checkbox"/>	<input type="checkbox"/>	<input type="checkbox"/>	<input type="checkbox"/>	<input type="checkbox"/>	<input type="checkbox"/>
<input type="checkbox"/>	<input type="checkbox"/>	<input type="checkbox"/>	<input type="checkbox"/>	<input type="checkbox"/>	<input type="checkbox"/>	<input type="checkbox"/>	<input type="checkbox"/>	<input type="checkbox"/>	<input type="checkbox"/>	<input type="checkbox"/>	<input type="checkbox"/>	<input type="checkbox"/>
<input type="checkbox"/>	<input type="checkbox"/>	<input type="checkbox"/>	<input type="checkbox"/>	<input type="checkbox"/>	<input type="checkbox"/>	<input type="checkbox"/>	<input type="checkbox"/>	<input type="checkbox"/>	<input type="checkbox"/>	<input type="checkbox"/>	<input type="checkbox"/>	<input type="checkbox"/>
<input type="checkbox"/>	<input type="checkbox"/>	<input type="checkbox"/>	<input type="checkbox"/>	<input type="checkbox"/>	<input type="checkbox"/>	<input type="checkbox"/>	<input type="checkbox"/>	<input type="checkbox"/>	<input type="checkbox"/>	<input type="checkbox"/>	<input type="checkbox"/>	<input type="checkbox"/>
<input type="checkbox"/>	<input type="checkbox"/>	<input type="checkbox"/>	<input type="checkbox"/>	<input type="checkbox"/>	<input type="checkbox"/>	<input type="checkbox"/>	<input type="checkbox"/>	<input type="checkbox"/>	<input type="checkbox"/>	<input type="checkbox"/>	<input type="checkbox"/>	<input type="checkbox"/>
<input type="checkbox"/>	<input type="checkbox"/>	<input type="checkbox"/>	<input type="checkbox"/>	<input type="checkbox"/>	<input type="checkbox"/>	<input type="checkbox"/>	<input type="checkbox"/>	<input type="checkbox"/>	<input type="checkbox"/>	<input type="checkbox"/>	<input type="checkbox"/>	<input type="checkbox"/>

Spezifische Informationen
Beachten Sie die dem Produkt beiliegenden zusätzlichen Informationen.

<input type="checkbox"/>	<input type="checkbox"/>	<input type="checkbox"/>	<input type="checkbox"/>	<input type="checkbox"/>	<input type="checkbox"/>	<input type="checkbox"/>	<input type="checkbox"/>	<input type="checkbox"/>	<input type="checkbox"/>	<input type="checkbox"/>	<input type="checkbox"/>	<input type="checkbox"/>
--------------------------	--------------------------	--------------------------	--------------------------	--------------------------	--------------------------	--------------------------	--------------------------	--------------------------	--------------------------	--------------------------	--------------------------	--------------------------



ES: IMPORTANTE: RECICLAJE.

Una vez finalizado el montaje:

- Deposita la caja de cartón en el contenedor de papel y cartón.
- Deposita las piezas plásticas no reutilizables en el contenedor de plásticos y envases.
- Si no quiere conservar este folleto, deposítalo en el contenedor de papel y cartón.

EN: IMPORTANT: RECYCLING.

Once assembly is complete:

- Place the cardboard box in the paper and cardboard recycling container.
- Place non-reusable plastic parts in the plastic and packaging recycling container.
- If you don't want to keep this leaflet, place it in the paper and cardboard recycling container.

FR: IMPORTANT : RECYCLAGE.

Une fois le montage terminé :

- Déposez la boîte en carton dans le conteneur pour papier et carton.
- Déposez les pièces en plastique non réutilisables dans le conteneur pour plastiques et emballages.
- Si vous ne souhaitez pas conserver ce livret, déposez-le dans le conteneur pour papier et carton.

IT: IMPORTANTE: RICICLAGGIO.

Una volta completato il montaggio:

- Smaltisci la scatola di cartone nel contenitore per carta e cartone.
- Smaltisci le parti in plastica non riutilizzabili nel contenitore per plastica e imballaggi.
- Se non desideri conservare questo libretto, gettalo nel contenitore per carta e cartone.

PT: IMPORTANTE: RECICLAGEM.

Após concluir a montagem:

- Coloque a caixa de cartão no contentor de papel e cartão.
- Coloque as peças plásticas não reutilizáveis no contentor de plásticos e embalagens.
- Se não quiser guardar este folheto, coloque-o no contentor de papel e cartão.

DE: WICHTIG: RECYCLING.

Nach dem Zusammenbau:

- Entsorge den Karton im Papier- und Kartoncontainer.
- Nicht wiederverwendbare Kunststoffteile gehören in den Container für Kunststoffe und Verpackungen.
- Wenn du dieses Heft nicht aufbewahren möchtest, wirf es in den Papier- und Kartoncontainer.



LE TRI
+ FACILE

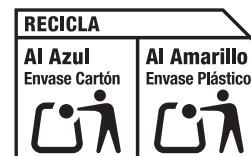

FR
Donnez ou recyclez vos meubles.



ou



ou



<https://quefairedemesdechets.fr>