

# LU 60 SENJA

v.2

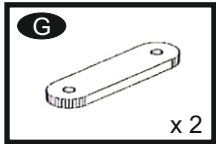

x 2

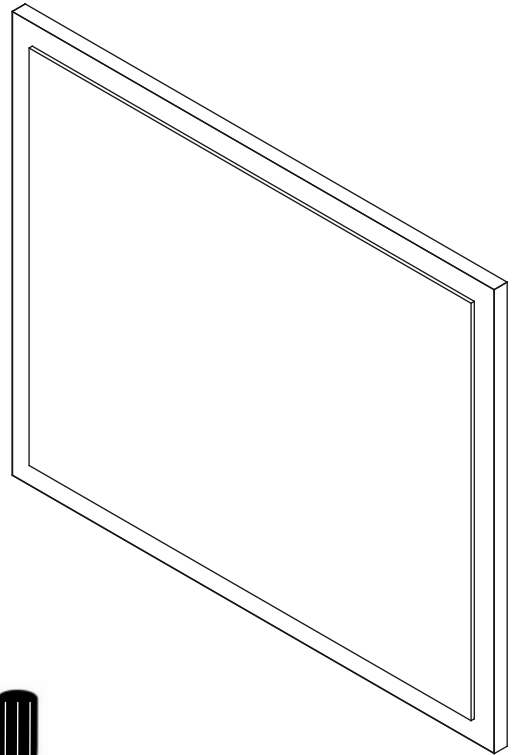
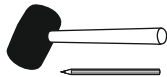
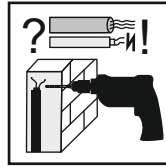
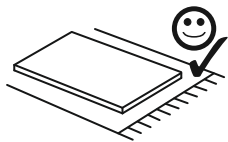
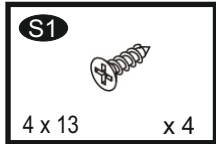

4 x 13

x 4

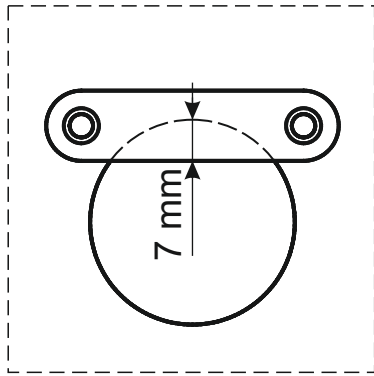

7 mm



S1



S1

G

