

<b>X</b> x 1	<b>S3</b> 4 x 12 x 6	<b>F2</b> x 2	<b>S4</b> 4 x 16 x 18	<b>F</b>	<b>ZA</b> x 8	
<b>G</b> x 10	<b>I</b> x 2	<b>J</b> 4 x 30 x 5	<b>K</b> x 2	<b>H</b> x 8	<b>B</b> x 8	
<b>S1</b> L-350 x 1 kpl.	<b>S2</b> L-400 x 1 kpl.	<b>Y</b> 6,3 x 13 x 16	<b>Z1</b> x 1 kpl.	<b>Z2</b> x 1 kpl.	<b>T1</b> x 1 kpl.	<b>T2</b> x 1 kpl.

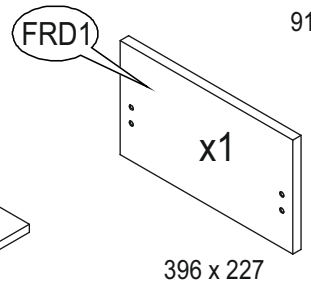

1

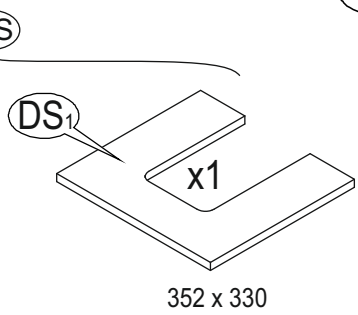
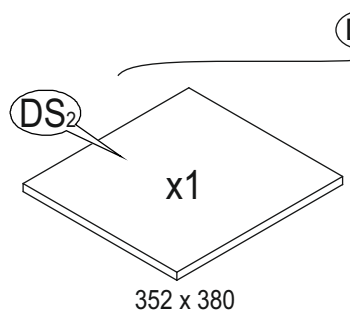
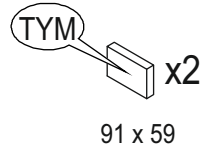
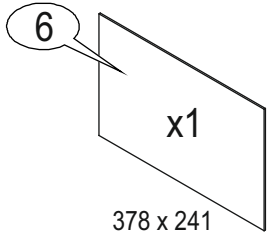
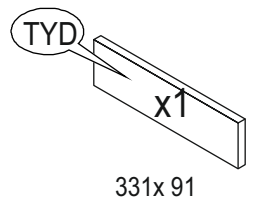
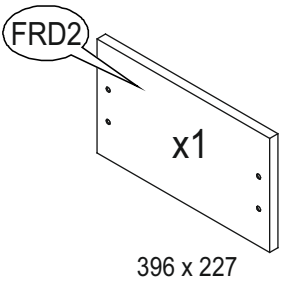
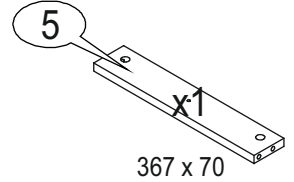
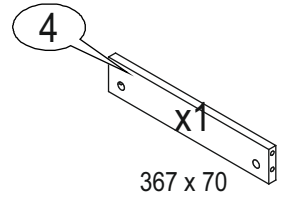
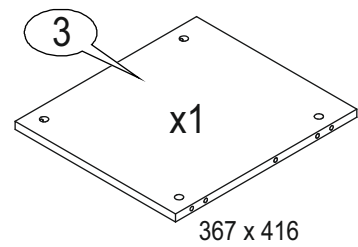
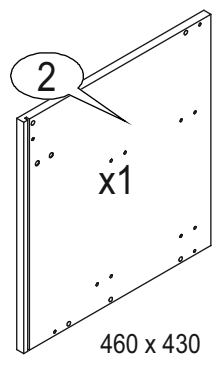
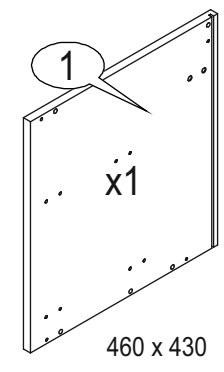
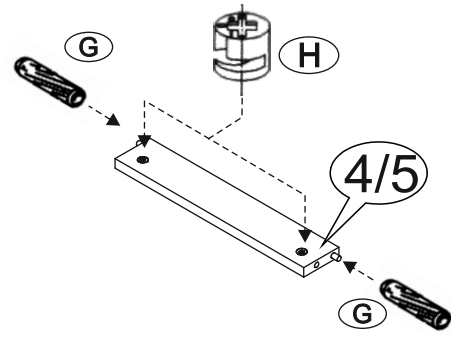
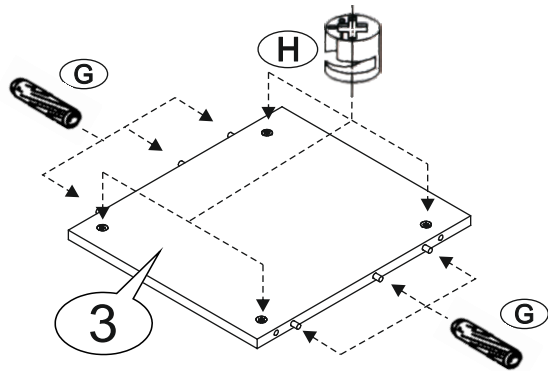
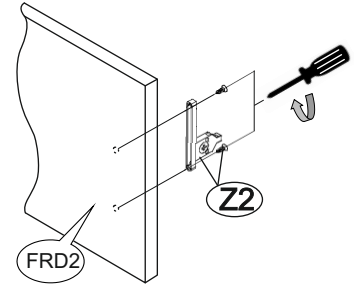
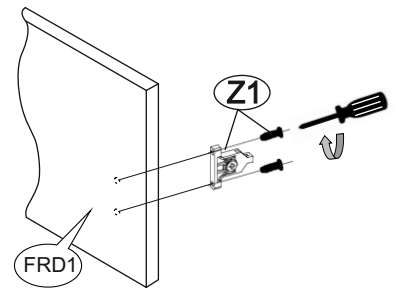
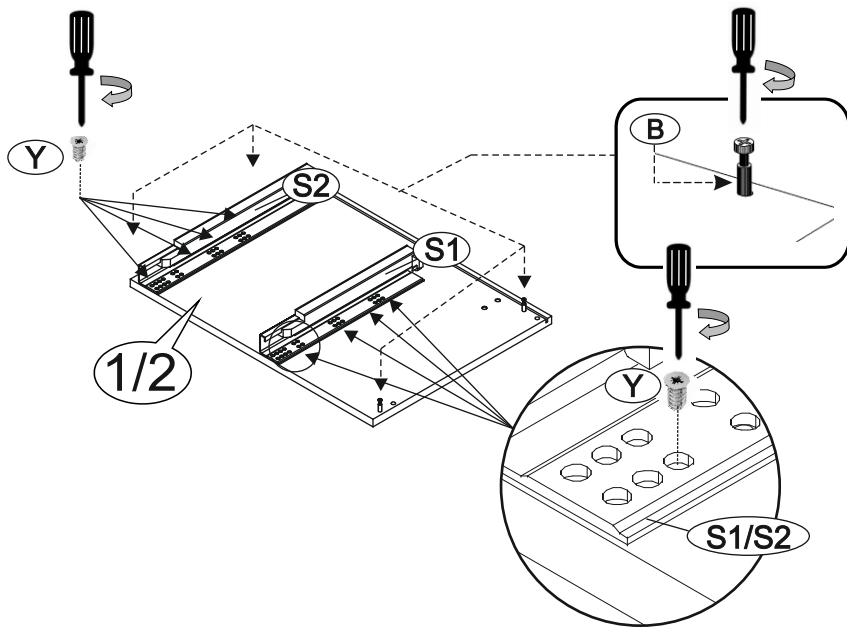

2

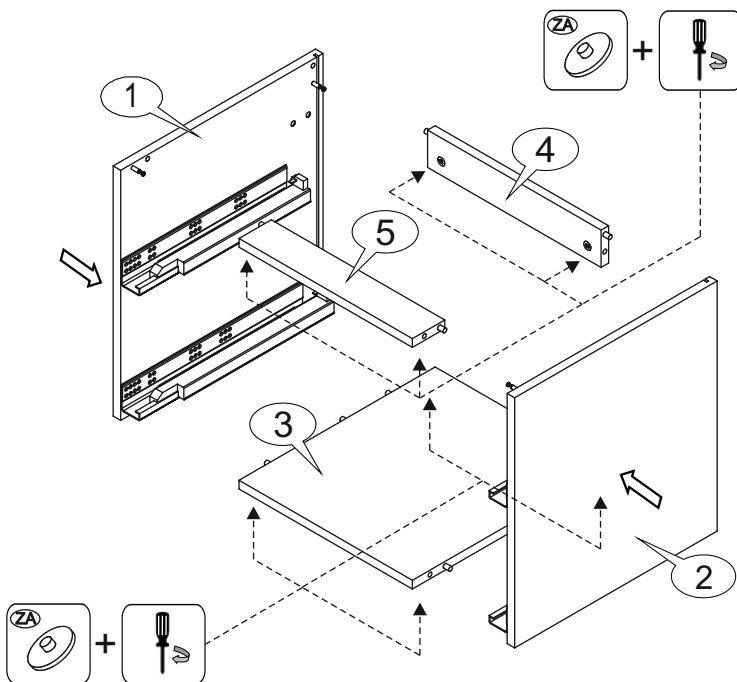

3

